

# Automatic Mask Production Line

**JLKZX-001**

智能自识别口罩全自动化生产线  
Intelligent Automatic Mask Production Line

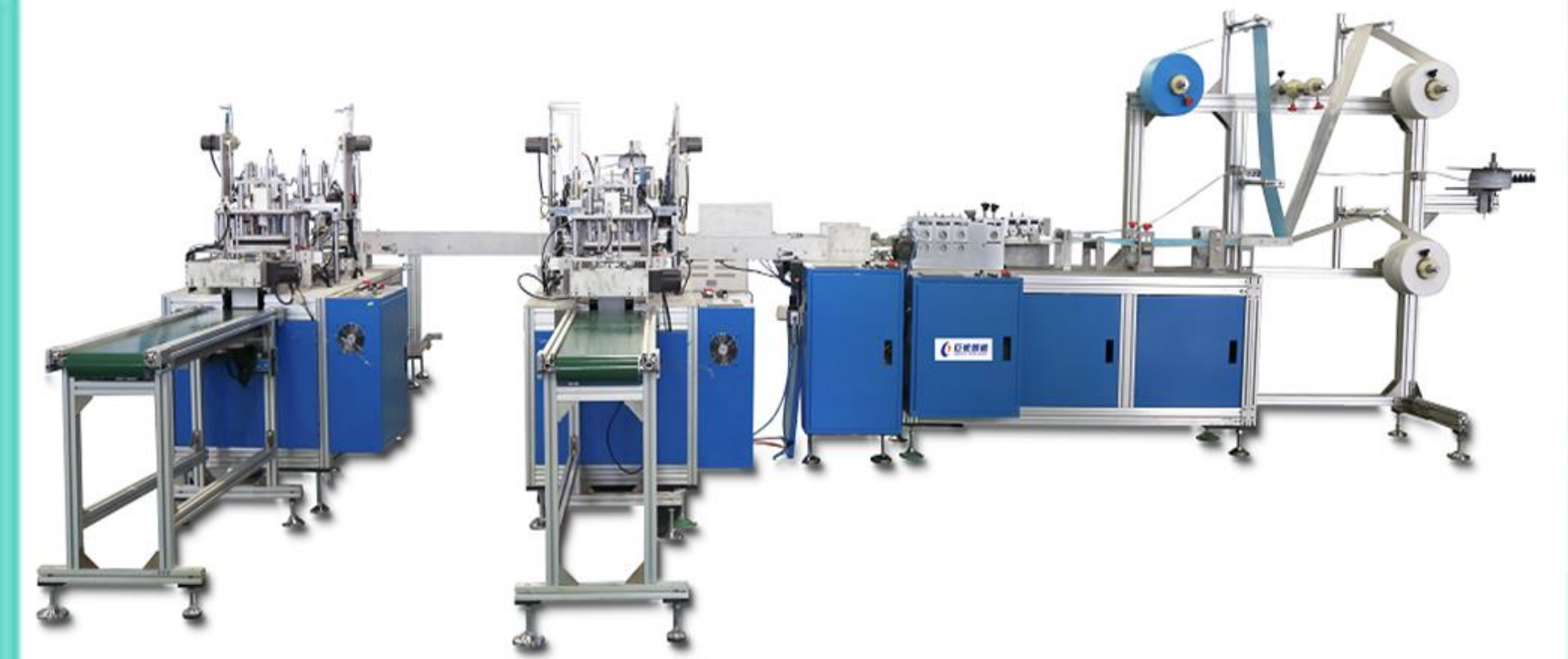

**Presented by:**

Colin Hong

Greatoo Intelligent Equipment Inc.

Web: [www.greatoo.com](http://www.greatoo.com)

Email: [colinhong@greatoindia.com](mailto:colinhong@greatoindia.com)

Cel: +86 1320 2441 462 (CH) | +91 755 0168 370 (IN)

# About Us

1. We are one of the leading manufacturers of CNC and automation equipment from China.
2. More than 20 years experience in automatic solution and projects
3. 90% of our customers are from the global top 100 players in their industry



# About Us

**Germany**  
德国

**Belgium**  
比利时

**Chennai**  
印度金奈

**Jie Yang**  
中国揭阳

**USA**  
美国

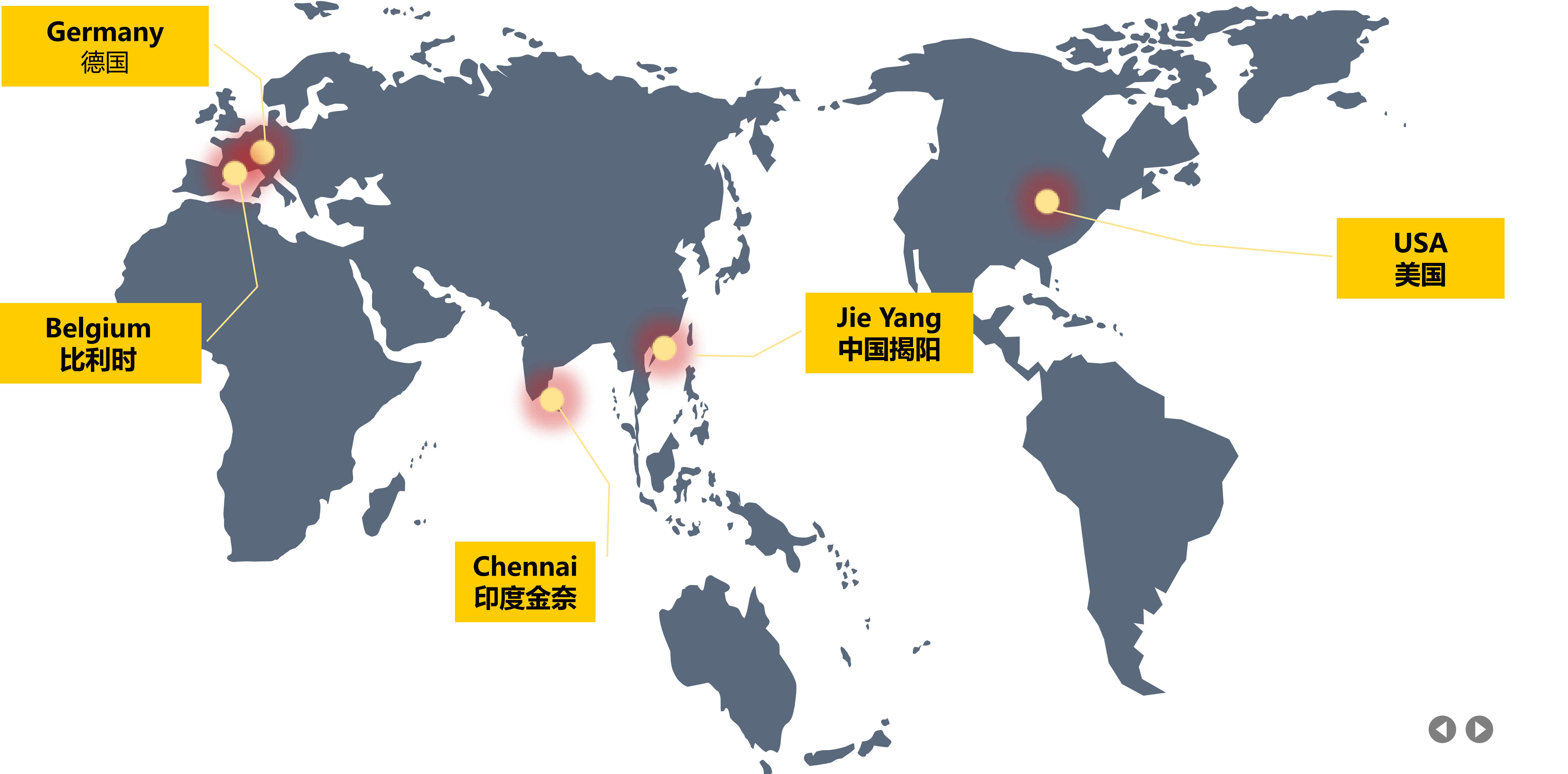

# About Us



## China Plant

(Tyre mold equipment)  
R&D)

## Robot Plant

(Automatic production line)

## India Plant

(Tyre mold equipment)

## USA Plant

(Tyre mold equipment)

## Germany Plant

(EDM technology)

# Machine Specifications

## Basic Information

Model	JLKZX-001
Size	6800*3800*2000mm (L/W/H)
Application	Medical/Non-medical plane masks
Structure	1+2 automatic design, generation 3
Capacity	80-100pcs/min
Material	AL 6061 anodic oxidized machine body

## Installation Environment

Power	/	8.8KW 220V 50Hz 60A
Ambient air temperature	°C	0~40
Humidity	/	<90%
Noise level	dBA	78.7
Altitude	m	≤1000
Design service life limit	year	10
Gross weight	kg	500
Pneumatic pressure	MPa	0.5-0.6



# Product Structure

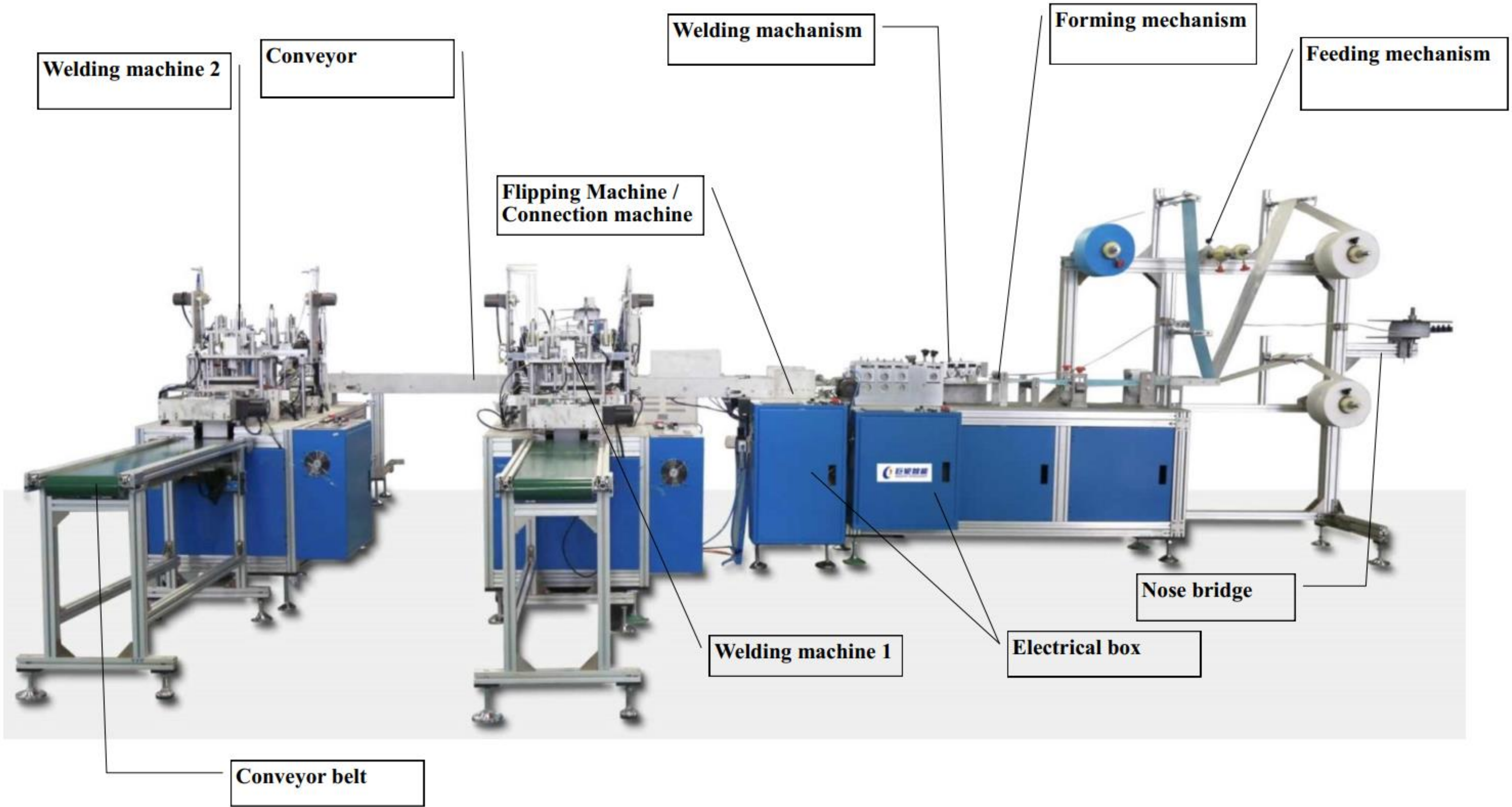

# Product Structure

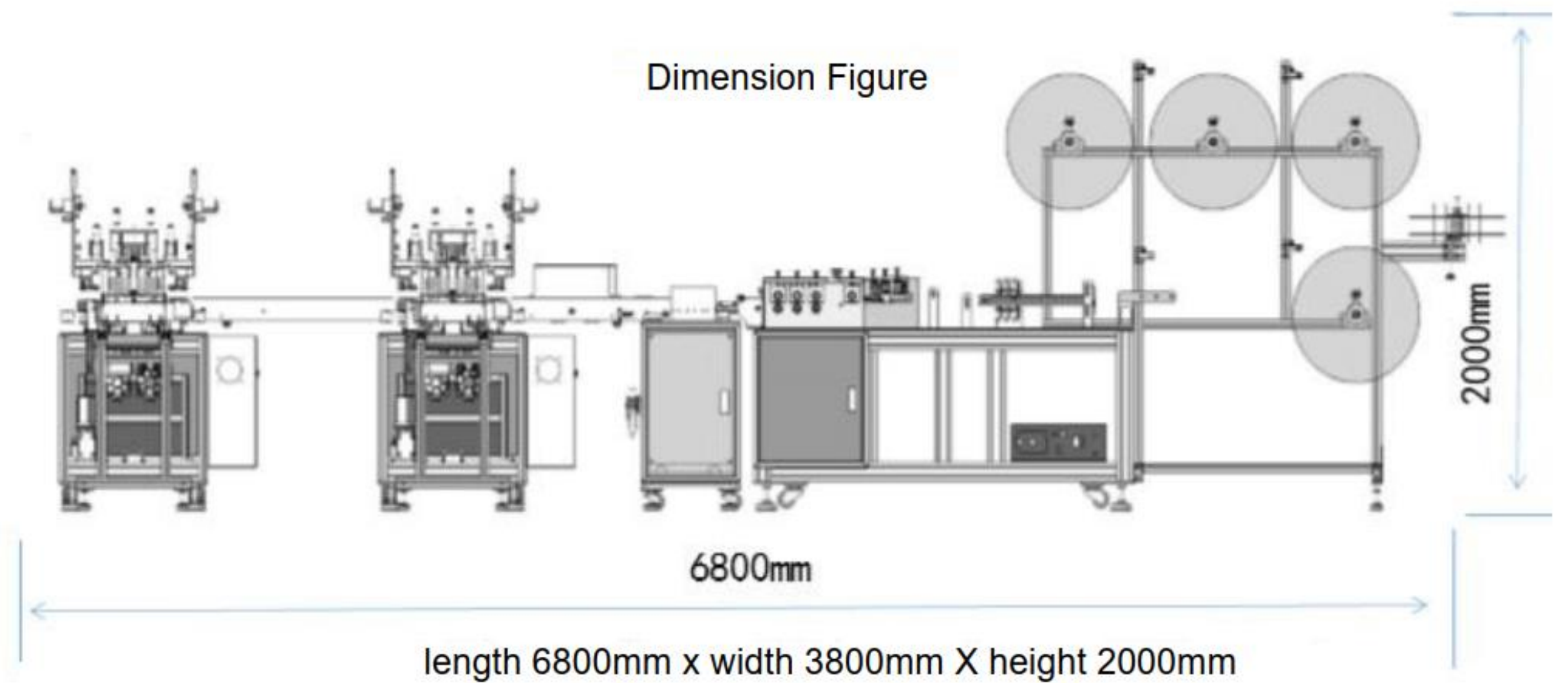
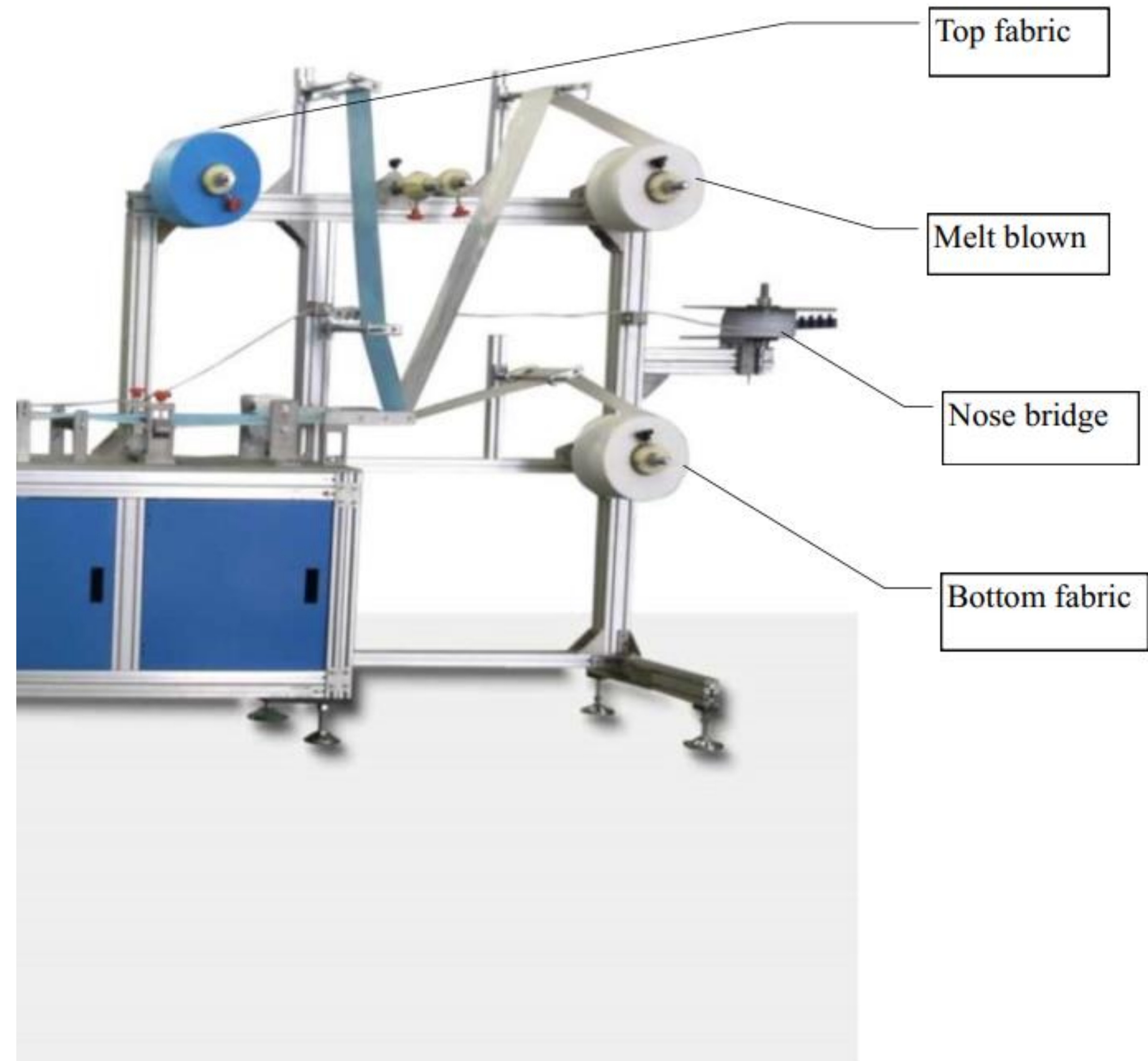

# Function introduction

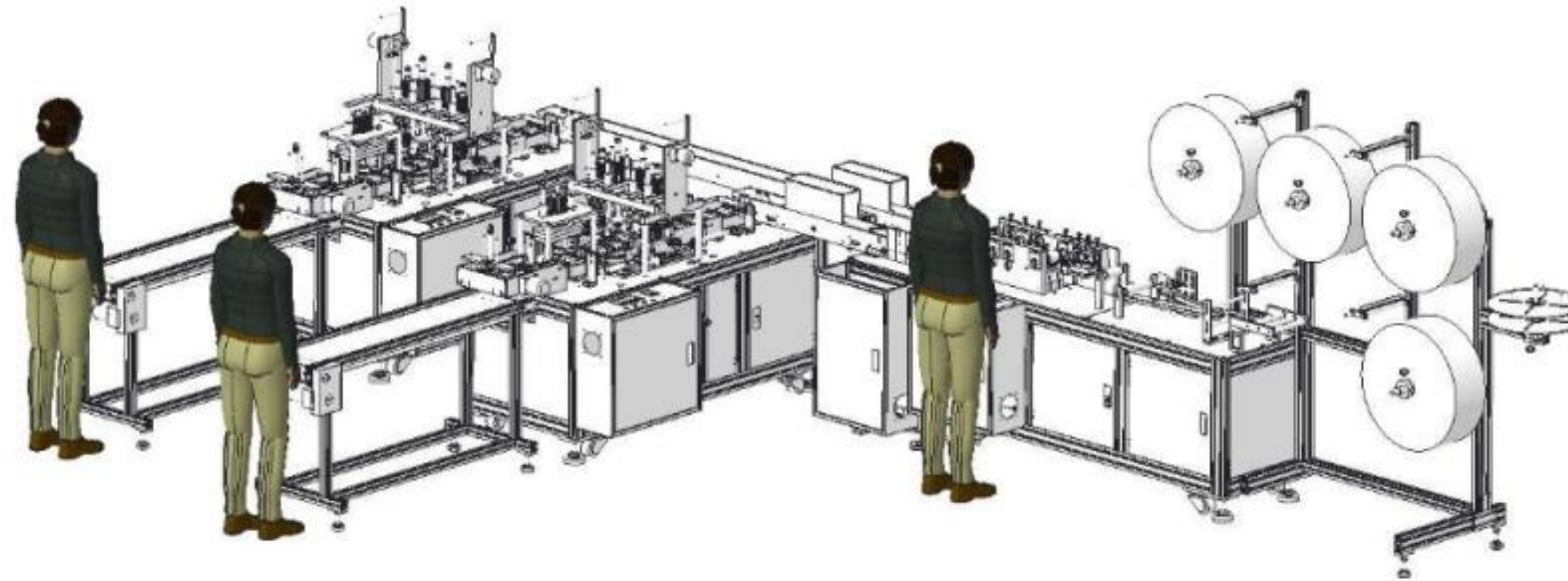
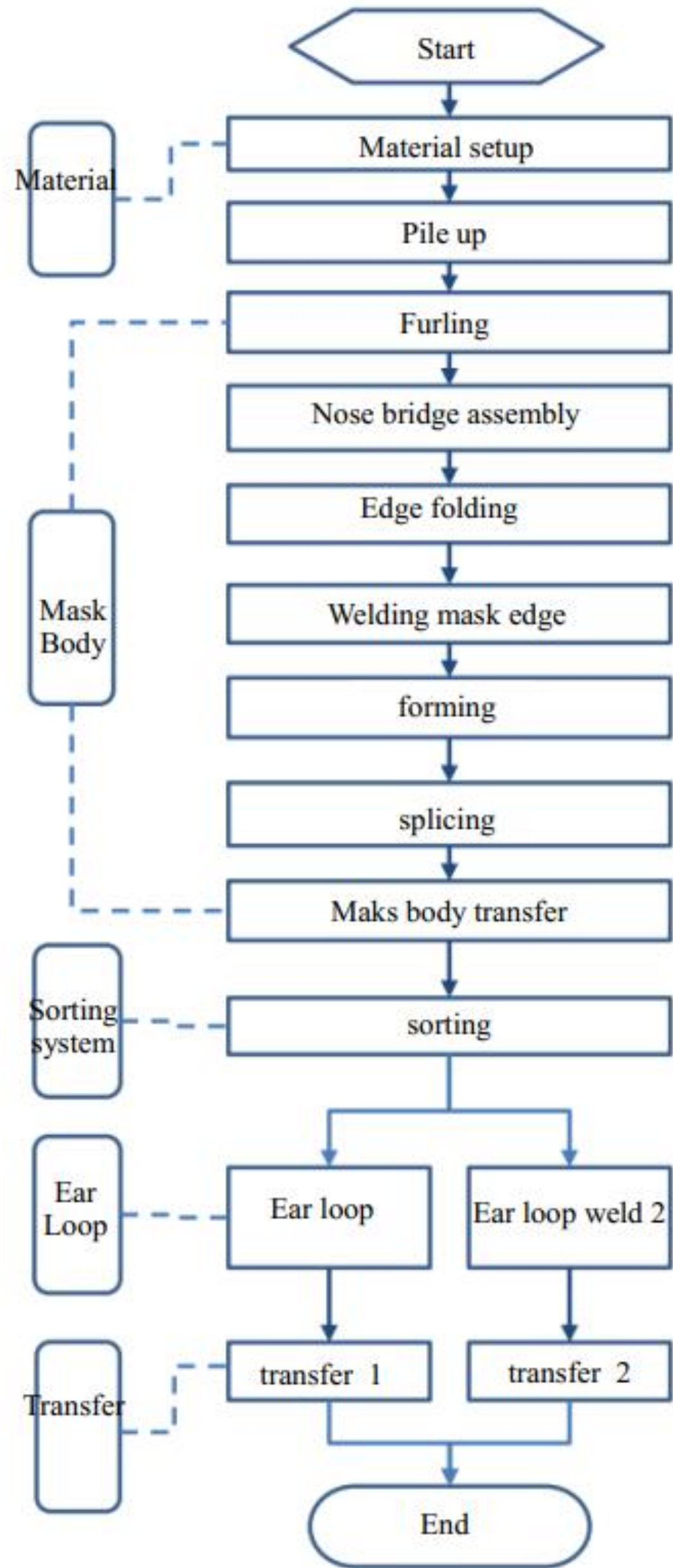



# Our Qualifications

SGS-CSTC Standards Technical Services Co., Ltd.  
 AFFILIATE CODE: F615921  
 CERTIFICATE NO.: IN-GZ-5305-200030



Page 1 of 1  
 Order No.: IN-GZ-5305-200030

### VERIFICATION OF COMPLIANCE

la vérification de la conformité

**Date of Issue:** 8<sup>th</sup> July 2020  
**Applicant (Name & Address):** GREATOO INTELLIGENT EQUIPMENT INC.  
 Rd.5 Jiedong Economic Development Zone, Jieyang, Guangdong, China  
**Manufacturer (Name & Address):** GREATOO INTELLIGENT EQUIPMENT INC.  
 Rd.5 Jiedong Economic Development Zone, Jieyang, Guangdong, China  
**Product Name Model(s)/Type(s):** Intelligent Self-Identify and Automatic Mask Production Line  
 JLKZX-001, JLKZX-003  
**Assessment Performed:** Conformity to Annex I's Applicable Paragraphs of 2006/42/EC Machinery Directive.  
**Standard(s) Referenced:** EN ISO 12100:2010; EN 60204-1:2018  
**Conditions Subject to issue:** Acceptance to information detailed in Technical file IN-GZ-5305-200030  
**Declaration:** In the Opinion of SGS the Submitted Technical File IN-GZ-5305-200030 Satisfies the Requirements of the Machinery Directive 2006/42/EC Annex-VII.

**Conclusion**  
 Based upon a review of the worksheet and the Technical Construction File, the apparatus is deemed to meet the requirements of the above standards and hence fulfils the requirements of:

**MACHINERY DIRECTIVE 2006/42/EC**

**Note:** This certificate is only valid for the equipment and configuration described and in conjunction with the technical data detailed above.  
 The CE mark as shown below can be used under the responsibility of the manufacturer, after completion of an EU Declaration of Conformity and compliance with all relevant EU Directives.

FOR AND ON BEHALF OF SGS-CSTC STANDARDS TECHNICAL SERVICES CO., LTD.



AUTHORIZED SIGNATURE  
 Meng Jie  
 Product Certification Manager  
 On Date 8<sup>th</sup> July 2020  
 \*\*\*\*\*

SGS-CSTC IND-C-01 Rev.00112017

SGSPAPER  
 20184381



This document is issued, on the Client's behalf, by the Company under its General Conditions of Service printed overleaf. The Client's attention is drawn to the limitation of liability, indemnification and jurisdiction issues defined therein.

Any other holder of this document is advised that information contained herein reflects the Company's findings at the time of its intervention only and within the limits of Client's instructions, if any. The Company's sole responsibility is to its Client and this document does not constitute part of a transaction between exercising all their rights and obligations under the transaction documents.

### Verification of Conformity



According to Electromagnetic Compatibility Directive 2014/30/EU

Certificate number: IN-GZ-5305-200030E  
 Licence Holder: GREATOO INTELLIGENT EQUIPMENT INC.  
 Address: Rd.5 Jiedong Economic Development Zone, Jieyang, Guangdong, China  
 Machinery description: Intelligent Self-Identify and Automatic Mask Production line  
 Identification of the type: JLKZX-001, JLKZX-003  
 Machinery parameters: AC220V, 50Hz  
 Technical file references: IN-GZ-5305-200030E  
 Applicable Standards: EN 61000-6-2:2005, EN 61000-6-4:2007+A1:2011  
 Date of Issue: 2020.07.07

Declaration: In the Opinion of SGS the Submitted Technical File IN-GZ-5305-200030E Satisfies the Requirements of the Electromagnetic Compatibility Directive 2014/30/EU.

**Conclusion**  
 Based upon a review of the worksheet and the Technical Construction File, the apparatus is deemed to meet the requirements of the above standards and hence fulfils the requirements of:

**Electromagnetic Compatibility Directive 2014/30/EU**

**Note:** This certificate is only valid for the equipment and configuration described and in conjunction with the technical data detailed above.  
 This certificate is valid until unless the directive or standards in question has been amended or superseded.  
 The CE mark as shown below can be used under the responsibility of the manufacturer, after completion of an EC Declaration of Conformity and compliance with all relevant EC Directives.

FOR AND ON BEHALF OF SGS-CSTC STANDARDS TECHNICAL SERVICES CO., LTD.  
 (a member of (SGS Group) Société Générale de Surveillance)



AUTHORIZED SIGNATURE



APPLIATE CODE: F615921  
 100, Dongyuan Road, Haidian, Beijing, China  
 Tel: 86-10-6045-1000  
 Fax: 86-10-6045-1015

This document is issued by the Company under the General Conditions of Service accessible at [www.sgs.com/terms-and-conditions.aspx](http://www.sgs.com/terms-and-conditions.aspx). Attention is drawn to the limitation of liability, indemnification and jurisdiction issues defined therein.

Any holder of this document is advised that information contained herein reflects the Company's findings at the time of its intervention only and within the limits of Client's instructions, if any. The Company's sole responsibility is to its Client and this document does not constitute part of a transaction between exercising all their rights and obligations under the transaction documents.



CHINA UNITED CERTIFICATION CENTER  
 CERTIFICATE OF CONFORMITY OF  
**QUALITY MANAGEMENT SYSTEM  
 CERTIFICATION**

Certificate No.: 01415Q10438R5M

This is to certify that the quality system of  
**GREATOO INTELLIGENT EQUIPMENT INC.**  
 Middle of the No.5 Road, Jiedong Economic Development Zone and Zhanqian Road,  
 Jiedong Economic Development Zone, Jieyang City, Guangdong Province;  
 (Registration Address: Middle of the No.5 Road, Jiedong Economic Development Zone,  
 Jieyang City, Guangdong Province), The People's Republic of China, ZIP: 515500  
 (Organization Code: 73500532-0)

is in conformity with  
**GB/T19001-2008/ISO9001:2008**

This certificate is valid to the following products/service:  
 Design, Production and Service of Rubber Machinery (Vulcanize Machine),  
 Various Tyre Moulds, Intelligent Automation System and Building Drum of Tyre

**Date of issue: 2015-09-18**      **Date of exchange: 2015-11-16**  
**Date of expiry: 2018-09-17**

(This certificate should be completed in standard transformation before September 15, 2018)  
 It is valid within the term of validity of all the administration and qualification stipulated in accordance with the regulation of P.R.C.  
 The organization certified must accept the surveillance audit on time during the period of validity of the certificate.  
 The certificate does not keep effective until passes the surveillance audit on time.  
 The certificate information can be found at the official website of CNCA ([www.cnca.gov.cn](http://www.cnca.gov.cn)).

*Ju zhi jian*  
 Representative of CUC





MANAGEMENT SYSTEM  
 CNAS C014-Q

Address: No.2 Capital Gymnasium South Road, Haidian, Beijing 100044, China

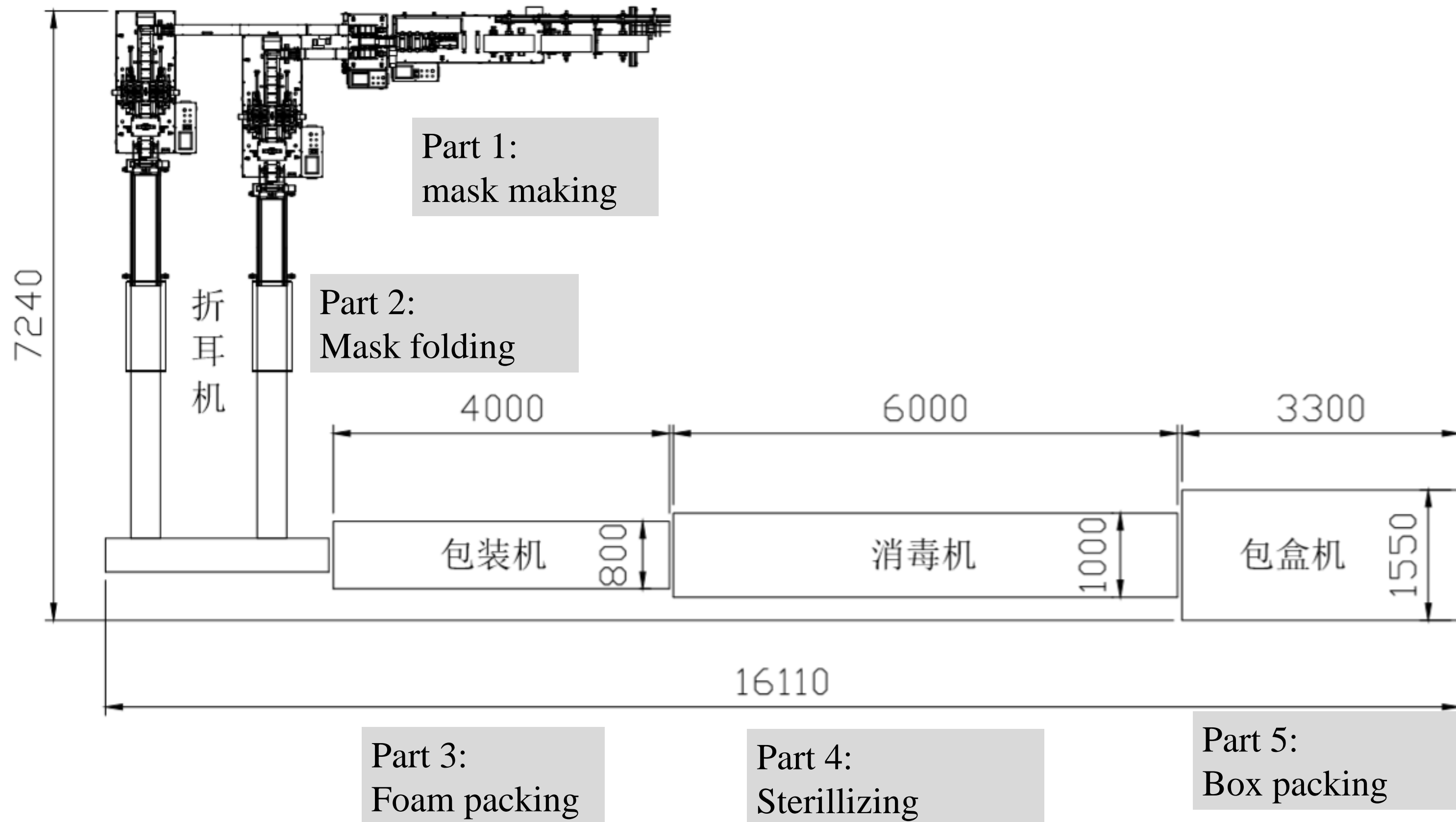
## A: Fully Automatic

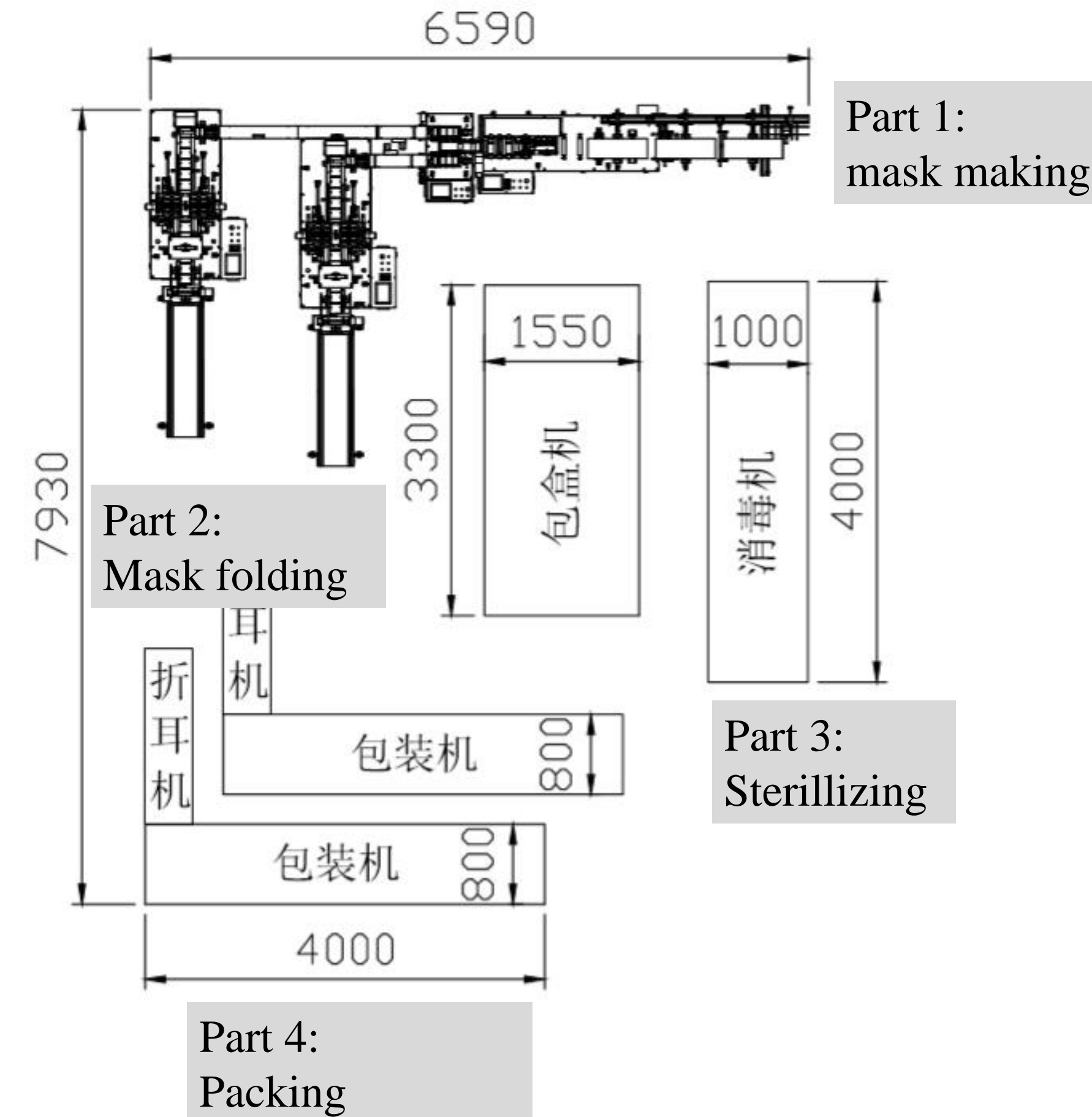

## B: Semi-Automatic



# Our Service

## Scope of Service

Installation	<ul style="list-style-type: none"><li>• Remote installation guidance through video and manuals</li><li>• On-site installation under third-party service</li></ul>
Warranty	<ul style="list-style-type: none"><li>• Free of defects within 1 year after dispatch</li></ul>
Training	<ul style="list-style-type: none"><li>• Online training on machine operations</li></ul>
Language support	<ul style="list-style-type: none"><li>• Bilingual support through calls/Conference meetings/PLC/Manual</li></ul>
Delivery	<ul style="list-style-type: none"><li>• 5-7 days after payment</li><li>• 20 machines/month</li><li>• Air/road/ocean delivery available</li></ul>
R&D support	<ul style="list-style-type: none"><li>• Customized service as per customer CAD drawings / IGES models</li><li>• Upgrading service in future models</li></ul>





# Quick-wear options

## 每台机免费赠送配件明细 (Free offer)

序号 No.	名称 Description	规格 Size	备注 Note
1	鼻梁切刀 Nose wire cutter	36*10*3	
2	口罩切刀 Facial Mask cutter	110*12.5*3	
3	焊头 Welding head	φ20*155	
4	皮带 Belt	厚2.5 宽15 周长520 thickness 2.5; width 15; perimeter 520	
5	皮带 Belt	厚2.5 宽15 周长590 thickness 2.5; width 15; perimeter 590	
6	皮带 Belt	厚2 宽15 周长475 thickness 2; width 15; perimeter 475	
7	皮带 Belt	厚2 宽15 周长1910 thickness 2; width 15; perimeter 1910	
8	皮带 Belt	厚2 宽15 周长4910 thickness 2; width 15; perimeter 4910	
9	气动剪刀 AIR NIPPERS	XG-23A	

## 选配明细 (Optional)

序号 No.	名称 Description	规格 Size	备注 Note
1	德诺牌数显超声波发生器 Ultrasonic generator	20K	
2	振旋牌普通超声波发生器 Ultrasonic generator	20K	
3	气缸 Air cylinder	TR10X50S	
4	电磁阀 Radiotube	4V210-08-B	
5	气缸 Air cylinder	ACQ20x30SB	
6	气缸 Air cylinder	ACQ140x20-20SB	
7	气缸 Air cylinder	ACQ140x45-40SB	
8	气缸 Air cylinder	HFZ16	

9	气缸 Air cylinder	HLH16X20S	
10	气缸 Air cylinder	MI20x100SCA	
11	气缸 Air cylinder	MI20x200SCMLB	
12	气缸 Air cylinder	TR6X10S	
13	油压缓冲器 Oil buffer	ACA1007-1	
14	浮动接头 Floating junction	F-M08 125F	
15	浮动接头 Floating junction	F-M14 150F	
16	调速阀 Speed control valve	PSL6-M5	
17	调速阀 Speed control valve	PSL6-01	
18	接头 Junction	APC6-02	

# Our Advantages

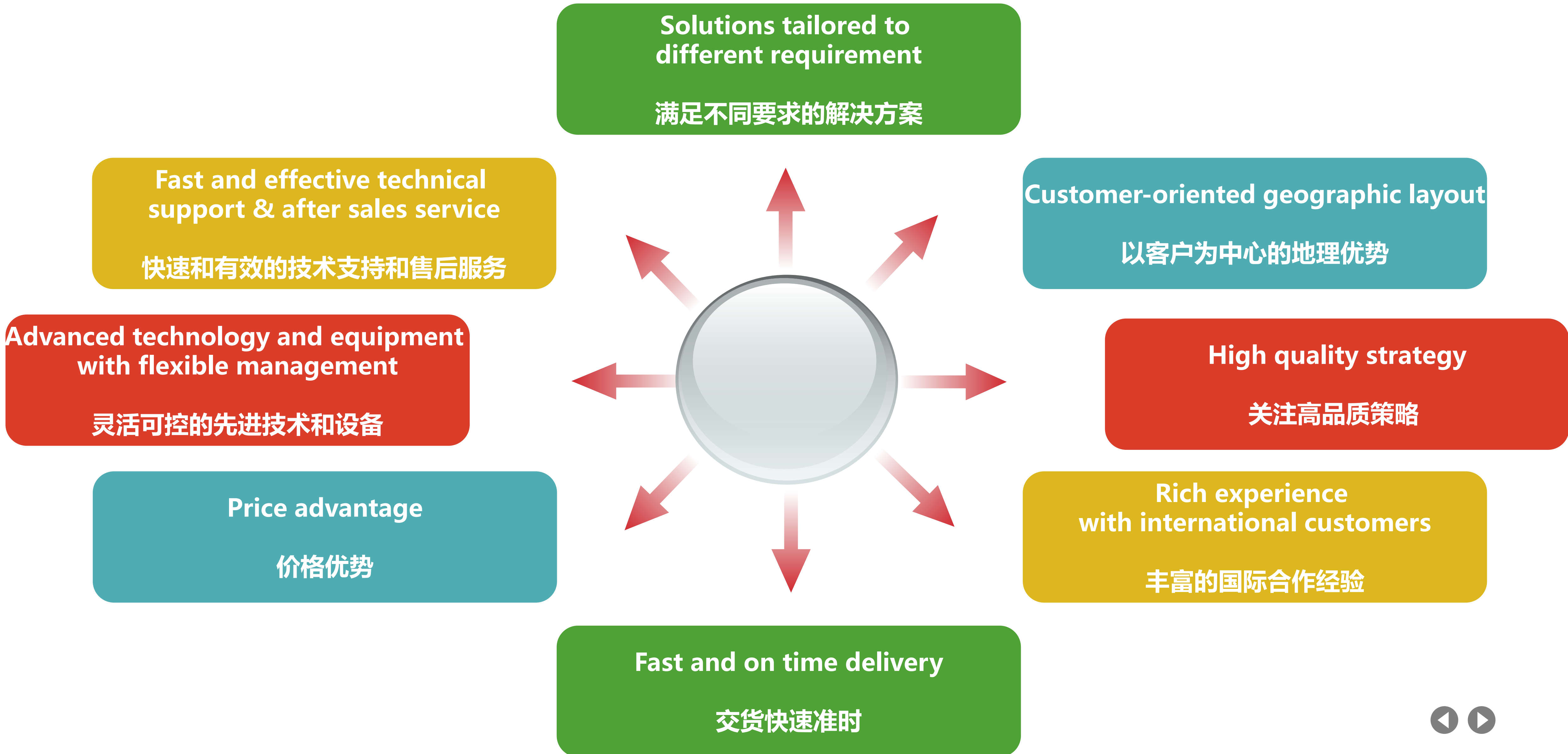

# Our Advantages



CNC machines with high accuracies  
高精度机床



专业仪器  
Inspection equipment



Program simulation  
程序模拟

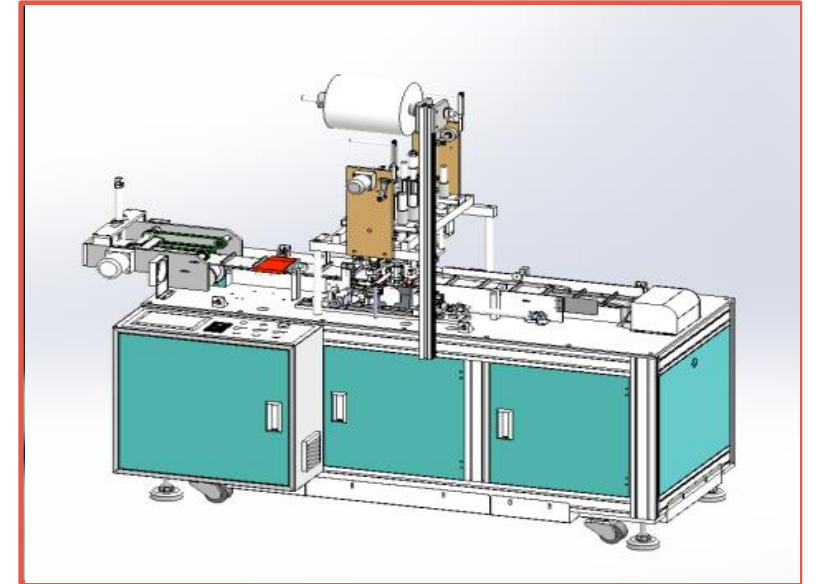

Professional inspectors  
专员检验



# Future Development

- Establish Greatoo Academy 创办巨轮学院
- Internal / external training 内外培训
- Globalized business management 商务国际化管理
- Accelerate delivery 加快交货
- New material application 新材料应用
- Laser engraving 激光雕刻
- Flexible machining development 柔式生产线研发
- CSR building 增强企业社会责任
- Eco-environment development 绿色发展

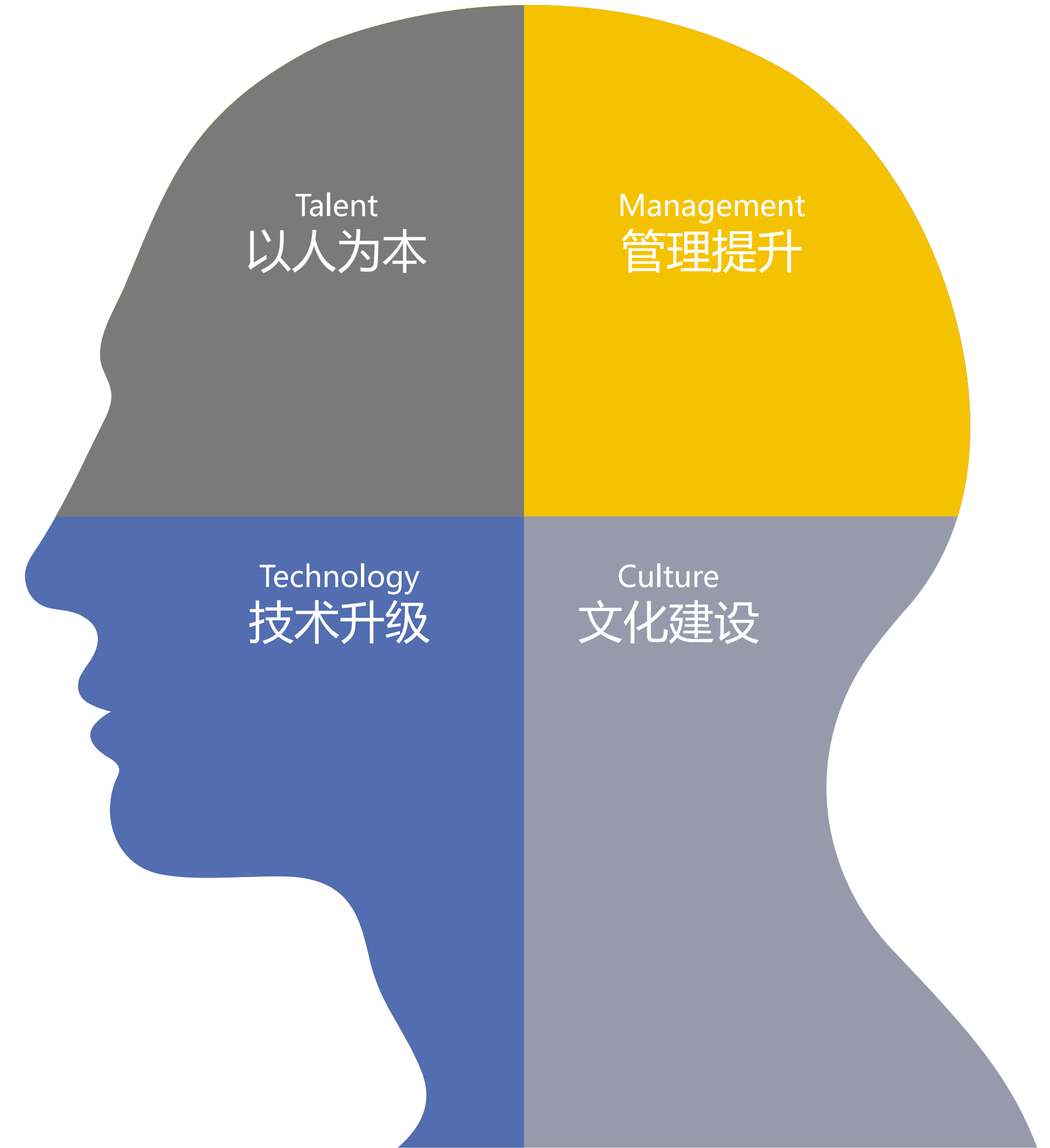

Thank You

创世界品牌 铸百年巨轮

争当同行业领先者，创造国际一流水准

